



vial azor

ficha técnica

datasheet

ref. 5551132

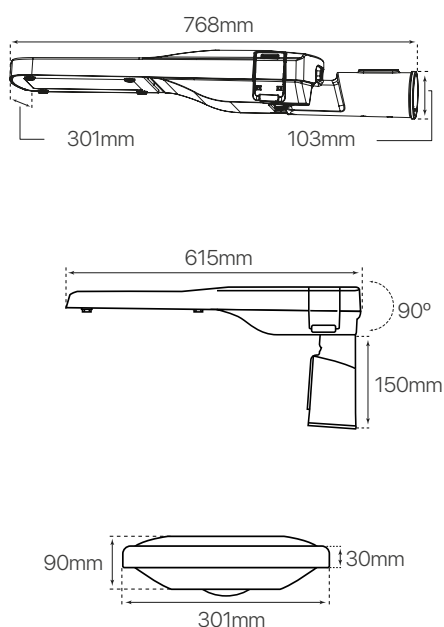

Nombre / Name	vial azor
Referencia / Reference	5551132
Materiales / Materials	Aluminio + cristal / Aluminum + glass
Difusor / Diffuser	PET
Potencia / Power	120W
Temperatura de color / Color temperature	4000K
Flujo luminoso / Luminous flux	18300lm
Dimable / Dimmable	Programado y ON-OFF
Ángulo de apertura / Beam angle	75° x 165°
Ángulo de inclinación / Inclination angle	90°
IP	65
IK	08
F.P	>0,9
UGR	<10
IRC	>80
Chip	PHILIPS Lumileds 3030
Driver	Inventronics EUK driver PROGRAMABLE
Vida media (duración) / Average life	50,000h
Clase energética / Energy class	A+
Aislamiento eléctrico / Electrical isolation	Clase I / Class I
Colores / Colors	Gris / Grey
Medida exterior / Product size	768mm x 301mm x 103mm
Medidas de corte / Cutting measurements	10kV
Tª (ambiente/trabajo) / Tª (environment/work)	-35°C~120°C
Input	AC90~305V
Output	48V
Frecuencia / Frequency	50/60Hz
Peso / Weight	8,31kg
Certificados / Certificates	CE&RoHS
Garantía / Warranty	2 años / 2 years